

# PRODUCT SHEET

## Description:

Invis. Semi Ext. Slide, Self closing, Pre-Zinc, 450mm, W/Quick Release & Inner Dampers

## Item number:

16.13.534-0

Units	Box	Carton	HS Code	Barcode
Pair	1	10	8302420090	
				5704866001090

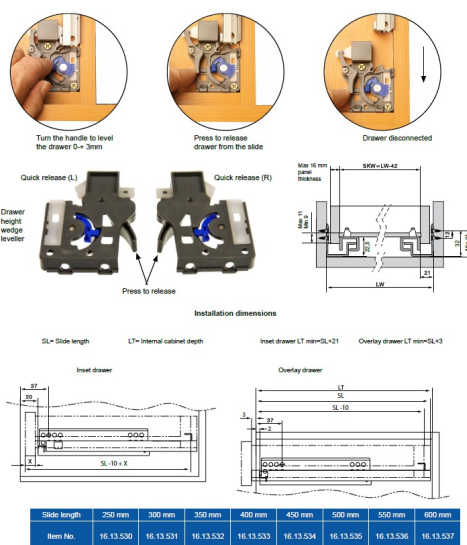
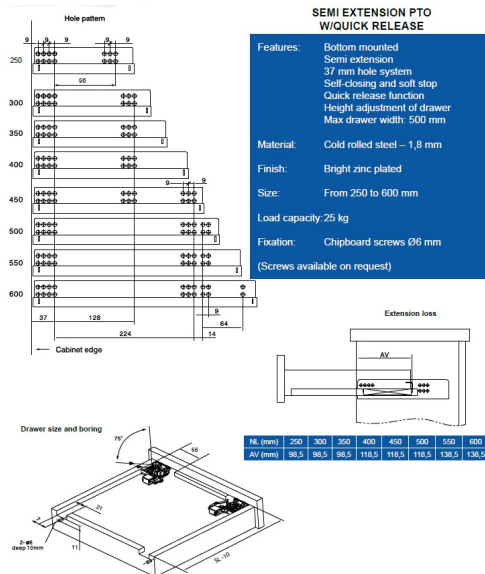
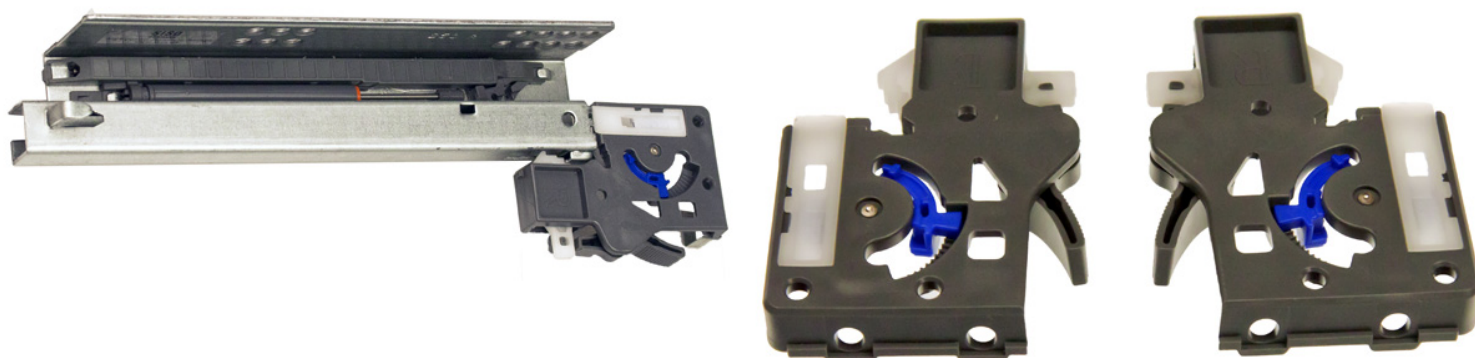

## SISO A/S

Mileparken 11  
 DK-2740 Skovlunde  
 Denmark  
 VAT: DK 24786013

Phone +45 45 830 900

www.siso.dk  
 siso@siso.dk

Danske Bank  
 Nytorv Branch  
 Copenhagen  
 SWIFT: DABADKKK

Account no.  
 4180 3112 112936  
 IBAN Account  
 DK7230003112112936